



R09PD

DATE: APRIL 07, 2009

TO: U.S. DEALERS

**SUBJECT: RECALL R09PD INCORRECT BOLTS AND/OR SPACER IN
ENGINE COOLING FAN**

Dear Blue Bird Owner:

This notice is sent to you in accordance with the requirements of the National Traffic and Motor Vehicle Safety Act.

Blue Bird has decided that a defect which relates to motor vehicle safety exists on 2008 and 2009 model year "Vision" conventional school buses manufactured from January 18, 2007 through October 29, 2008 and equipped with Caterpillar C7 and C7 07engines.

On the subject buses, incorrect bolts and/or spacers may have been installed to attach the fan blade to the fan clutch. As a result, the fan blade may separate from the clutch and potentially cause property damage or personal injury to persons in or near the front of the bus. Blue Bird is conducting a recall to correct this defect. Buses with this defect must be modified according to the enclosed instructions for Recall R09PD

If our records indicate affected buses were delivered in your service area, a printout identifying affected buses is enclosed. **Dealers should verify correct owners and assure that complete shipping addresses are provided for each listed vehicle.**

If you have in your possession or have sold a bus that was purchased from another dealer that may be affected by this recall, please notify me at 478-822-2242.

NOTE: If Service Bulletin S08NR has already been completed on a unit no further action is required.

Replacement bolts will be shipped directly to owners so bolts can be replaced, if needed, at time of inspection.

Dealers should request replacement bolts for buses at their facility from Blue Bird Recall Administration. Dealers will need to provide the body number for each bus requiring inspection at their facility.

BLUE BIRD CORPORATION
P.O. Box 937 • Fort Valley, Georgia 31030
Phone: (478) 825-2021

Labor time to inspect for correct bolt and spacer installation is 0.1 hrs (6 minutes) per bus.

Labor time to install replacement bolts and spacer, if needed, is 0.4 hrs (24 minutes) per bus.

If the spacer is incorrect you will need to contact Blue Bird Recall Administration at 478-822-2242 for a replacement spacer. Dealers will need to provide body numbers for each bus requiring a replacement spacer.

Warranty applications for labor reimbursement may be submitted to Blue Bird iWarranty (Campaigns/Claims).

Federal law requires that any vehicle lessor receiving this recall notice must forward a copy of this notice to the lessee within ten days.

Dealers are reminded of their responsibilities under section 154 of The National Traffic and Motor Vehicle Safety Act of 1991. Dealers are required to complete modifications on units in their inventory before delivering to the final owner. Reference Blue Bird Body Company Distributor Memo No. 42-92.

Questions regarding this recall campaign should be directed to me at (478) 822-2242.

Thank you,



Bill Coleman
Corporate Recall Administrator
Blue Bird Corporation



R09PD

April 07, 2009

Dear Blue Bird Owner:

This notice is sent to you in accordance with the requirements of the National Traffic and Motor Vehicle Safety Act.

Blue Bird has decided that a defect which relates to motor vehicle safety exists on certain 2008 and 2009 model year "Vision" conventional school buses manufactured from January 18, 2007 through October 29, 2008 and equipped with Caterpillar C7 and C7 07 engines.

On the subject buses, incorrect bolts may have been installed to attach the fan blade to the fan clutch. On some of the buses incorrect spacers may also have been installed. As a result, the fan blade may separate from the clutch and potentially cause property damage or personal injury to persons in or near the front of the bus. Blue Bird is conducting a recall to correct this defect.

Buses with this defect must be modified according to the enclosed instructions for Recall R09PD. A qualified technician should perform Recall R09PD or you may contact your Blue Bird dealer for assistance.

Your Blue Bird bus(es) affected by this recall are identified by body serial number(s) on the enclosed reply sheets. If you no longer own the subject bus(es), please complete the appropriate section of the pink reply sheet and return to Blue Bird in the enclosed pink postage prepaid envelope.

NOTE: If Service Bulletin S08NR has already been completed on your bus(es) no further action is required.

Replacement bolts for Recall R09PD are enclosed with this notification so replacement bolts, if needed, can be installed at time of inspection.

Labor time to inspect for correct bolt and spacer installation is 0.1 hrs (6 minutes) per bus.

Labor time to install replacement bolts and spacer, if needed, is 0.4 hrs (24 minutes) per bus.

If the spacer is incorrect, you will need to contact Blue Bird Recall Administration at 478-822-2242 to obtain a replacement spacer. Owners will need to provide the body numbers for each bus requiring a replacement spacer.

Reimbursement for labor may be obtained by completing the **pink** request for reimbursement sheet provided and returning it to Blue Bird in the enclosed **pink** postage prepaid envelope.

If the modifications directed by this notification were performed on your bus prior to the receipt of this recall notification, complete and sign the recall reply sheet and attached a copy of the work order/invoice. Mail the documents in the **pink** self-addressed postage paid envelope included with the recall notification to Blue Bird for warranty consideration. Reimbursements will be made in accordance with the requirements of the National Highway Transportation Safety Act, Title 49 Code of Federal Regulations, Parts 573 and 577.

Federal law requires that any vehicle lessor receiving this recall notice must forward a copy of this notice to the lessee within ten days.

If Blue Bird Body Company should fail to or is unable to remedy this condition without charge to you, you may contact:

**ADMINISTRATOR
NATIONAL HIGHWAY TRAFFIC SAFETY ADMINISTRATION
1200 NEW JERSEY AVENUE, SE
WASHINGTON, D.C. 20590**

Or, you may call The National Highway Traffic Safety Administration toll free at:

1-888-327-4236
TTY 1-800-424-9153

Or, go to: [HTTP://WWW.SAFERCAR.GOV](http://WWW.SAFERCAR.GOV)

Questions regarding this recall campaign should be directed to me at (478) 822-2242.

Thank you,



Bill Coleman
Corporate Recall Administrator
BLUE BIRD CORPORATION



Fan Clutch Spacers

MODELS AFFECTED: 2008-2009 BBCV Visions w/ 2007 Cat Engines

RECALL

ISSUE

Fan may separate from fan clutch and may damage fans blades, fan clutch, radiator, hoses and other surrounding components.

CORRECTIVE ACTION

Inspect fan spacer length and install new spacer and bolts as required.

WARNING Always follow all Federal, State, Local, and Shop safety standards and use proper safety equipment when performing this procedure.

INSPECTION

- 1 Park vehicle on a level surface, apply parking brake, turn engine off, remove ignition key and chock wheels.
- 2 Disconnect batteries.
- 3 Open engine hood.
- 4 Measure the length of the spacer between the fan blade and the fan clutch. See Diagram and Chart to the right for correct installations and determine procedure needed.

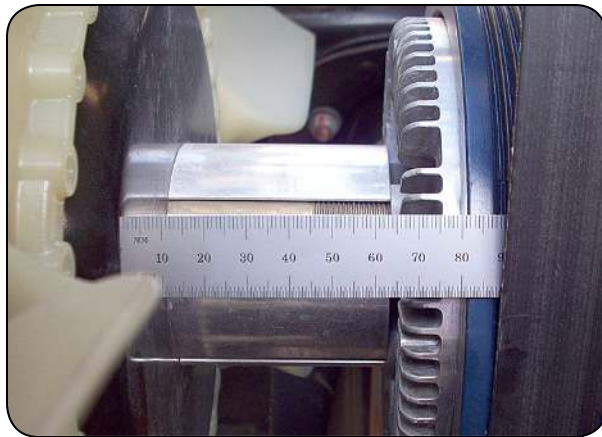

Inspection

PROCEDURE 2 (with wrong spacer and wrong capscrews)
For CAT C707 with CGI & DPF, and a 52.8mm (2 5/64 inch) spacer.
Note: Caterpillar C707 with CGI and DPF has a Regen switch mounted on the entrance door side fire wall.

PROCEDURE 3 (with wrong spacer and wrong capscrews)
For CAT C7 without CGI & DPF, or Export unit; with a 66.7mm (2 5/8 inch) spacer.

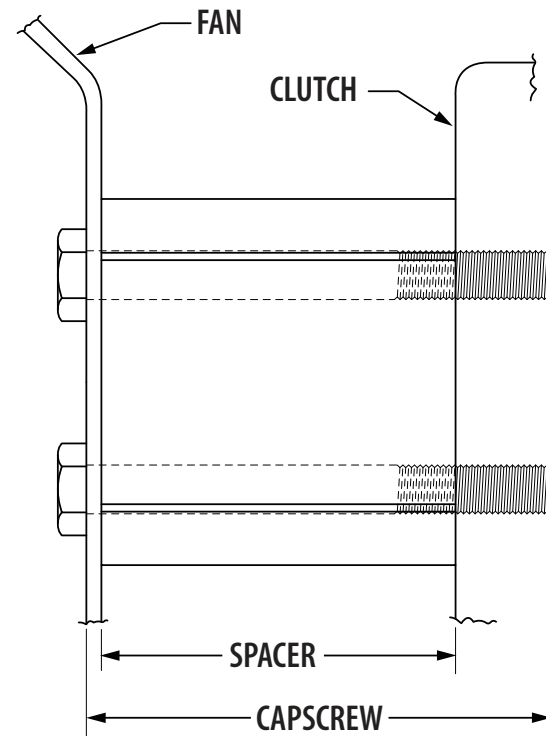

PROCEDURE 1 (with correct spacer and wrong capscrews)
For CAT C707 with CGI & DPF, and a 66.7mm (2 5/8 inch) spacer.
Note: Caterpillar C707 with CGI and DPF has a Regen switch mounted on the entrance door side fire wall.

NOTE: CAT C707 engines are equipped with Clean Gas Induction (CGI) and a Diesel Particulate Filter (DPF). CAT C7 and Export units are not equipped with CGI and DPF.

ENGINE	SPACER	CAPSCREW
CAT C707 with CGI & DPF	66.7mm (2 5/8 inches)	90mm M10-1.5 X 90mm
CAT C7 or Export without CGI & DPF	52.8mm (2 5/64 inches)	70mm M10-1.5 X 70mm

R09PD

S E R V I C E R E C A L L



PROCEDURE 1 (With correct spacer and wrong capscrews.)

For CAT C707 with CGI & DPF, and a 66.7mm (2 5/8 inch) spacer.
Note: Caterpillar C707 with CGI and DPF has a Regen switch mounted on the entrance door side fire wall.

1 Remove and retain the four nuts attaching the fan shroud to the radiator. Slide the shroud rearward for access to the four capscrews attaching the fan to the fan clutch.

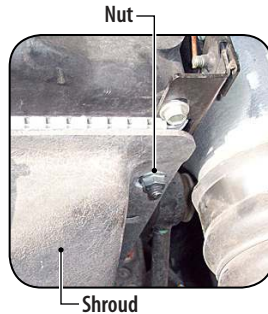

2 Remove the four 80mm capscrews and discard. Retain the four lock washers.

3 Install four 90mm capscrews (Blue Bird #10000385) with four lock washers and torque to 20-25 lb. ft. Note: Four 90mm capscrews (Blue Bird #10000385) shipped with original Service Bulletin.

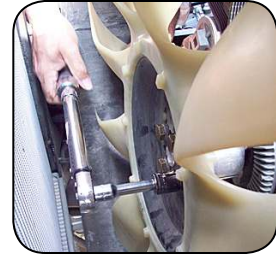

4 Slide fan shroud forward and reattach with four nuts removed in step one.

5 Close engine hood.

6 Reconnect batteries and place the bus back in service.

PARTS LIST

PART NUMBER	QUANTITY	DESCRIPTION
10000385	4	*Capscrew, Hex head, M10-1.5 x 90mm*

Supplied with original Service Bulletin.

PROCEDURE 2 (With wrong spacer and wrong capscrews.)

For CAT C707 with CGI & DPF, and a 52.8mm (2 5/64 inch) spacer.
Note: Caterpillar C707 with CGI and DPF has a Regen switch mounted on the entrance door side fire wall.

1 Remove and retain the four nuts attaching the fan shroud to the radiator. Slide the shroud rearward for access to the four capscrews attaching the fan to the fan clutch.

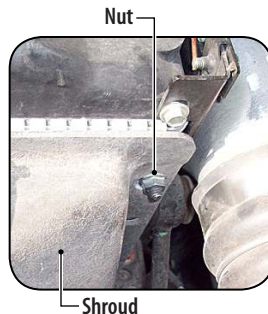

2 Remove and discard the four 80mm capscrews and spacer. Retain the four lock washers.

3 Install new Spacer (Blue Bird #10005240) with four 90mm capscrews (Blue Bird #10000385) and four lock washers. Torque to 20-25 lb. ft.

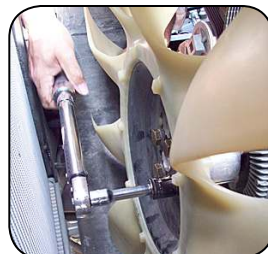

4 Slide fan shroud forward and reattach with four nuts removed in step one.

5 Close engine hood.

6 Reconnect batteries and place the bus back in service.

PARTS LIST

PART NUMBER	QUANTITY	DESCRIPTION
10005240	1	Spacer, Clutch, Fan, Horton, 00115258
10000385	4	**Capscrew, Hex head, M10-1.5 x 90mm**

Order only if not provided

R09PD SERVICE RECALL



PROCEDURE 3 (Export only with wrong spacer and wrong capscrews.)

For CAT C7 without CGI & DPF, or Export unit; with a 66.7mm (2 5/8 inch) spacer.

1 Remove and retain the four nuts attaching the fan shroud to the radiator. Slide the shroud rearward for access to the four capscrews attaching the fan to the fan clutch.

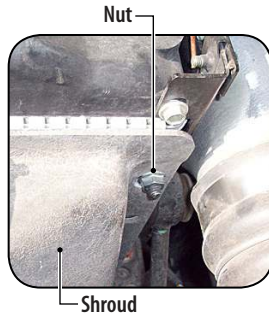

2 Remove and discard the four capscrews and spacer. Retain the four lock washers.

3 Install new Spacer (Blue Bird #10005241) with four 70mm capscrews (Blue Bird #01265990) and four lock washers. Torque to 20-25 lb. ft.

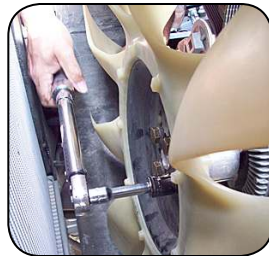

4 Slide fan shroud forward and reattach with four nuts removed in step one.

5 Close engine hood.

6 Reconnect batteries and place the bus back in service.

PARTS LIST

PART NUMBER	QUANTITY	DESCRIPTION
10005241	1	Spacer, Clutch, Fan, Horton, 00068057
01265990	4	Capscrew, Hex head, M10-1.5 x 700mm

R09PD
S E R V I C E R E C A L L